



victron energy

**USER MANUAL
GEBRUIKSAANWIJZING**

Phoenix 12/1000

CE

Copyrights © 1999, 2000 Victron Energy B.V.
All Rights Reserved

This publication or part thereof, may not reproduced in any form by any method, for any purpose.

VICTRON ENERGY B.V. MAKES NO WARRANTY, EITHER EXPRESSED OR IMPLIED, INCLUDING BUT NOT LIMITED TO ANY IMPLIED WARRANTIES OF MERCHANTABILITY OR FITNESS FOR A PARTICULAR PURPOSE, REGARDING THESE VICTRON ENERGY PRODUCTS AND MAKES SUCH VICTRON ENERGY PRODUCTS AVAILABLE SOLELY ON AN “AS-IS” BASIS.

IN NO EVENT SHALL VICTRON ENERGY B.V. BE LIABLE TO ANYONE FOR SPECIAL, COLLATERAL, INCIDENTAL, OR CONSEQUENTIAL DAMAGES IN CONNECTION WITH OR ARISING OUT OF PURCHASE OR USE OF THESE VICTRON ENERGY PRODUCTS. THE SOLE AND EXCLUSIVE LIABILITY TO VICTRON ENERGY B.V., REGARDLESS OF THE FORM OF ACTION, SHALL NOT EXCEED THE PURCHASE PRICE OF THE VICTRON ENERGY PRODUCTS DESCRIBED HERE IN.

For conditions of use and permission to use this manual for publication in other than the Dutch or English language, contact Victron Energy B.V.

Victron Energy B.V. reserves the right to revise and improve its products as it sees fit. This publication describes the state of this product at the time of its publication and may not reflect the product at all times in the future.

English description

Page 4

Nederlandse beschrijving

Pagina 19

SAFETY RULES

General

Please familiarise yourself with the safety features and instructions by first reading the documentation supplied with this product before using the equipment. This product has been designed and tested in accordance with international standards. The equipment must be used exclusively for the purpose for which it was designed.

WARNING: ELECTRIC SHOCK HAZARD.

The product is used in conjunction with a permanent energy source (battery). Input and/or output terminals may still be dangerously energised, even when the equipment is switched off. Always switch off the A/C supply and the battery before carrying out maintenance or servicing the product.

The product has no internal user-serviceable components. Do not remove the front plate or operate the product if any panels have been removed. All servicing must be undertaken by qualified personnel.

Never use the product where there is a risk of gas or dust explosions. Consult the battery manufacturer's information to ascertain that the product is intended for use in conjunction with the battery. Always comply with the battery manufacturer's safety instructions.

WARNING: Do not lift heavy loads without assistance.

Installation

Read the installation instructions in the user manual before switching on the equipment.

This is a Safety Class I product (supplied with a protective earthing terminal). Uninterruptable protective earthing must be provided at the AC input and/or output terminals. An additional earth point is located externally on the product. Whenever it is likely that the earth protection has been damaged, the product must be turned off and secured against unintended operation; please contact qualified service staff.

Ensure that the in-leads are fitted with fuses and circuit breakers. Never replace a safety component with a different type. Consult the manual to determine the correct component.

Before applying power, ensure that the available power source matches the configuration settings of the product as described in the manual.

Ensure that the equipment is used under the correct ambient conditions. Never operate the product in a wet or dusty environment. Ensure there is adequate free space for ventilation around the product and check that the ventilation vents are not blocked.

Ensure that the required voltage does not exceed the product's capacity.

Transport and Storage

Ensure that the mains power and battery leads have been disconnected before storing or transporting the product.

No liability can be accepted for any transport damage if the equipment is shipped in non-original packaging.

Store the product in a dry environment; the storage temperature must be between -20°C en 60°C.

Consult the battery manufacturer's manual in respect of transport, storage, charging, recharging and disposal of the battery.

TABLE OF CONTENTS

1. INTRODUCTION	6
2. INSTALLATION	6
2.1 Placement of the inverter.	6
2.2 Using the "Remote On/Off" function	7
2.3 The ground terminal	8
2.4 Battery requirements	8
2.4.1 Using power supplies instead of batteries.	8
2.5 Connection to the battery.	8
2.5.1 General precautions about working with batteries	9
2.6 The serial communication port	10
2.7 Connecting the load	10
2.8 Turning on the inverter	11
3. SELF DIAGNOSIS SYSTEM / TROUBLESHOOTING	11
3.1 The blink sequence table	11
3.2 Acoustical messages	12
3.3 Troubleshooting guideline	13
4. WARRANTY	14
5. MAINTENANCE / FUSE REPLACEMENT	15
5.1 Maintenance	15
5.2 Replacing fuses	15
6. TECHNICAL SPECIFICATIONS / DECLARATION OF CONFORMITY.	17
6.1 Phoenix 12/1000	17
6.2 Declaration of conformity.	18

1. INTRODUCTION

Thank you for choosing a Phoenix DC to AC inverter. The Phoenix inverter series are one of the most sophisticated inverters available today. With high reliability, efficiency and sine quality as our most important design goals, the Phoenix inverter series is developed to serve you with safe and trouble free operation for years.

Your Phoenix inverter features an advanced micro processor control system with a MOSFET power stage and a low loss toroidal transformer. This toroidal transformer in combination with well over dimensioned power components, ensures very reliable operation, so that extreme overload conditions, like startup of compressors or pumps, can be handled safely.

To get optimum feedback from your inverter while operating, a built in diagnosis system will warn you of status optically by different blinking sequences, depending on the error situation. See the troubleshooting chapter for the blinking sequence table. Also, the inverter will warn you acoustically before it's going to shut down due to low battery, overload or high temperature condition. A bidirectional communication port is available too, for future options like a remote panel or connection to a network of power system equipment.

To get optimum performance and safe operation from your inverter, it must be installed and used properly. Please read this manual very carefully, especially the **warning** and **caution** statements, before installing and using your Phoenix inverter.

2. INSTALLATION

2.1 Location of the inverter

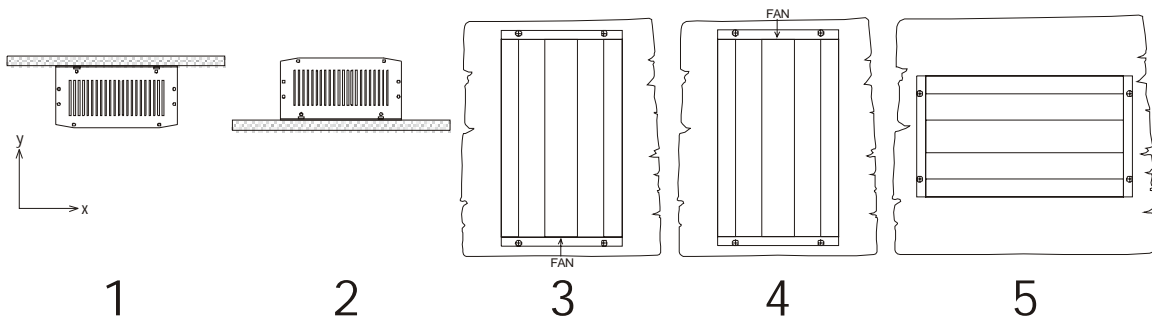

1. Ceiling mounting : Only recommended when ceiling is fixed and not removable
2. Floor mounting : **OK**
3. Vertical wall mounting, fan at bottom : **OK** (beware of small objects falling through the ventilation openings on top)
4. Vertical wall mounting, fan on top : Not recommended (reduces inverter capacity due to insufficient cooling)
5. Horizontal wall mounting : **OK**

For best operating results, the inverter should be placed on a flat surface. To ensure a trouble free operation of the inverter, it must be used in locations that meet the following requirements :

- a. Avoid any contact with water on the inverter. Do not expose the inverter to rain or moisture.
- b. Do not place the unit in direct sunlight or other high temperature environments. Ambient air temperature should be between 0 °C and 40 °C (humidity < 95% non condensing). Note that in some extreme situations the inverter's case temperature can exceed 70 °C.

- c. Do not obstruct the airflow around the inverter. Leave at least 10 centimeters clearance around the inverter. Do not place items on or over the inverter while it's operating. When the inverter is running too hot, it will shut down until a safe temperature level is reached to restart the inverter.
- d. Never use the inverter in locations where there is gas or explosion danger, for example directly on top of batteries, or close to volatile liquids.
- e. Do not expose the inverter to dusty environments

2.2 Using the "Remote On/Off" function

This Phoenix inverter offers the possibility to connect an external (remote-) on/off SPST switch (min. 60VDC/1A). The two wires of the external switch must be connected to the terminals blocks as indicated below. Before connecting an external switch, the factory installed link wire must be removed first. Make sure that when installing the remote switch, the battery is NOT connected yet!

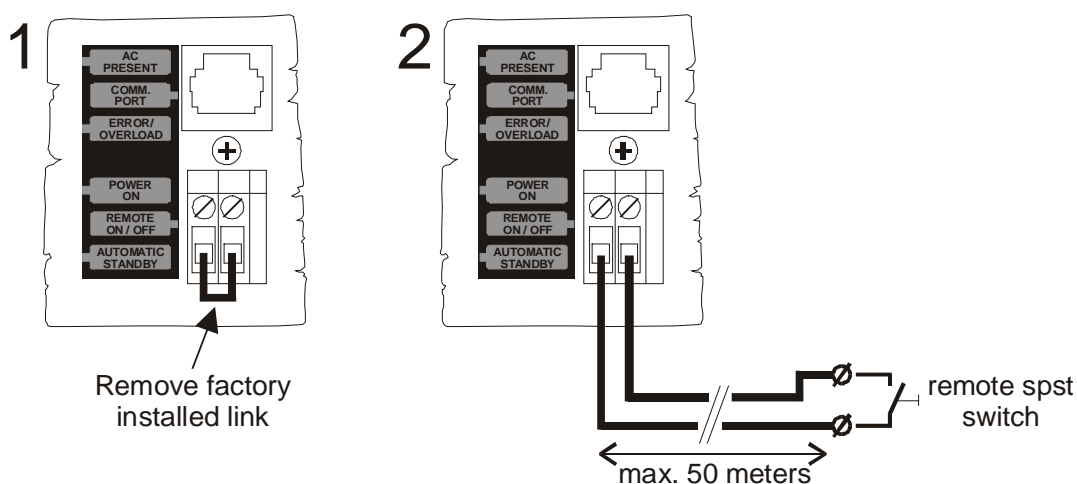

The main on/off switch on the inverter frontpanel always overrides the remote on/off switch. So in order to use the remote switch, the main on/off switch must be in the ON or Automatic standby (ASB) position. Maximum recommended length of the remote switch wires are 50 meters. Use professional quality wiring for these connections to avoid easy wire damage. The recommended wire gauge is 0.2mm² (AWG24) or greater.



CAUTION

MAKE SURE THAT WHEN INSTALLING THE REMOTE SWITCH, THE BATTERY IS NOT CONNECTED YET.

2.3 The ground terminal

In order to complete the grounding circuit of your AC system, the inverter's housing can be connected to ground by using the dedicated ground screw. See the figure below for the location of the ground screw. Use a wire gauge of at least 2.5mm² (AWG13) for the ground wire.

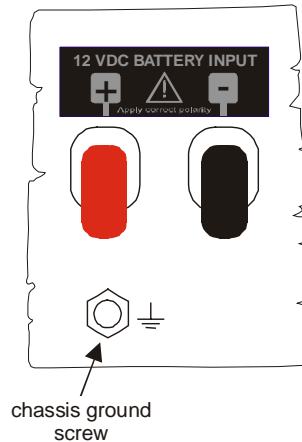

2.4 Battery requirements

For correct operation, the battery voltage should be between 11V and 14.4V. The recommended battery capacity is ≥ 300 Ah. This capacity can be halved for short time inverter usage not requiring more than nominal output power. The DC input current at nominal output power is approx. 88A.

The inverter shuts down when the battery voltage is below approx. 10.5V and above approx. 16V. When the battery voltage is too low or too high, first the inverter will generate one beep per second to inform you about a possible inverter shut down. This acoustic message will start at a battery voltage close to the shutdown voltage.

The inverter also shuts down when too high input ripple voltage is detected, reducing the inverter's lifetime. High input ripple voltage values are mostly caused by using too small batteries and/or extending the DC cables too much or with insufficient wire gauge. When the inverter shuts down due to too high input ripple voltage, indicated by four blinks per second, it must be restarted manually.

 <p>CAUTION</p>	<p>THE PHOENIX 12/1000 MUST BE CONNECTED ONLY TO A 12V BATTERY SYSTEM.</p> <p>The inverter will not operate from a 6V battery and will be damaged when connected to battery voltages higher than 16V.</p>
--	--

2.4.1 Using power supplies instead of batteries

It is not recommended to power the inverter directly from a DC power supply when full inverter performance is required. Most power supplies are not able to supply the huge surge currents required by the inverter, and usually generate a too high ripple voltage causing the inverter's high ripple protection to trip.

2.5 Connection to the battery

The Phoenix 12/1000 is equipped with two 25 mm² wires with a length of 1.5 meters. Unless it is absolutely necessary, Victron Energy advises not to extend the battery wires. Extending the battery wires may increase system losses and can cause inverter malfunctioning like tripping the input ripple protection circuit. If it is unavoidable to extend these wires, use a wire gauge of at least 1.5 times larger than the ones supplied with the inverter. Maximum recommended battery wire length is approx. 3 meters. Make sure that the joint between the original wires and the extension wires is made solid and with very low electrical resistance in mind.



CAUTION

TO AVOID FIRE HAZARDS CAUSED BY DAMAGED DC WIRES, ALWAYS PLACE A BATTERY SYSTEM FUSE AS CLOSE AS POSSIBLE TO YOUR BATTERY TERMINALS.

Recommended battery fuse size is : 150A..200A



CAUTION

THE RED WIRE MUST BE CONNECTED TO THE POSITIVE (+) TERMINAL AND THE BLACK WIRE TO THE NEGATIVE (-) TERMINAL OF THE BATTERY.

Reverse polarity connection of the battery wires can damage the inverter! Damage caused by reversed polarity is not covered by the warranty. Make sure the powerswitch is in the OFF '0' position before connecting the battery.

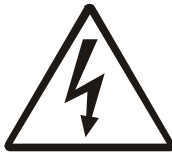

WARNING

IF THE INVERTER IS CONNECTED TO THE BATTERY WITH INCORRECT POLARITY, THE DC FUSE WILL BLOW.

To replace the internal DC fuse, see chapter 5.2 for further information. If the fuse blows again, even with the correct polarity applied, the inverter is damaged and must be returned for service.

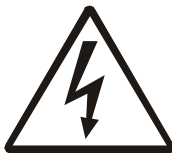

WARNING

DO NOT CONNECT OTHER DC POWERED EQUIPMENT TO THE SAME BATTERY THAT POWERS YOUR INVERTER.

It's possible that the performance of some equipment, that isn't properly protected against ripple current, may be affected when connected to the same battery that powers the inverter.

This doesn't apply for batterychargers and lighting.

2.5.1 General precautions about working with batteries

1. Working in vicinity of a lead acid battery is dangerous. Batteries can generate explosive gases during operation. Never smoke or allow a spark or flame in vicinity of a battery. Provide sufficient ventilation around the battery.
2. Wear eye and clothing protection. Avoid touching eyes while working near batteries. Wash your hands when done.
3. If battery acid contacts skin or clothing, wash immediately with soap and water. If acid enters eye, immediately flood eye with running cold water for at least 15 minutes and get medical attention immediately.
4. Be careful when using metal tools in vicinity of batteries. Dropping a metal tool onto a battery might cause a shorted battery and an explosion.
5. Remove personal metal items such as rings, bracelets, necklaces, and watches when working with a battery. A battery can produce a short-circuit current high enough to weld a ring or the like to metal, causing severe burns.

2.6 The serial communication port

The Phoenix 12/1000 inverter is equipped with an RS485 serial communications port for future use. The communication port wiring is designed to work with a standard RJ45 terminated Ethernet compatible patch cable. Maximum recommended cable length is approx. 50 meters.

	<p>DO NOT CONNECT THE INVERTER'S SERIAL COMMUNICATION PORT TO AN ETHERNET NETWORK OR TO ANY OTHER NON COMPATIBLE NETWORKS. THIS COMMUNICATION PORT IS FOR FUTURE OPTIONS.</p>
---	--

2.7 Connecting the load

Before you connect your appliance(s) to the inverter output, always check it's maximum power consumption. Do not connect appliances to the inverter needing more than the nominal power rating of the inverter continuously. Some appliances like motors or pumps, may draw high inrush currents during startup. In this kind of situations, it is possible that the startup current exceeds the overcurrent trip level of the inverter. In this case the output voltage will quickly decrease to limit the output current of the inverter. If this overcurrent trip level is continuously exceeded, the inverter will shut down and restart within 18 seconds. In this case it is advisable to disconnect this appliance from the inverter, since it requires too much power to be driven by this inverter. Note that at higher ambient temperature levels, the overload capacity of the inverter is reduced.

Besides indicating the type of error, the red LED on the inverter also functions as an overload indicator. When heavy loads are switched on, this LED will quickly be activated due to the inrush current of the load. If the ERROR/OVERLOAD LED stays on for 6 seconds, the inverter will shut down and jumps into the overload error mode (see chapter 3.1)

	<p>NEVER CONNECT THE INVERTER'S OUTPUT TO THE AC DISTRIBUTION GRID, LIKE YOUR HOUSEHOLD AC WALL OUTLET. IT WILL DAMAGE THE INVERTER.</p>
---	---

	<p>WHEN CONNECTING MORE THAN ONE APPLIANCE TO THE INVERTER, IN COMBINATION WITH A COMPUTER, NOTE THAT IF ONE OF THE APPLIANCES STARTS UP, IT CAN CAUSE YOUR COMPUTER TO REBOOT DUE TO A SUDDEN VOLTAGE DROP.</p>
---	---

2.8 Turning on the inverter

When all the above requirements are checked and satisfied and all connections are made, it's time to turn on your Phoenix inverter by pushing the power switch in the 'I' position. After a short two tone beep, the sinewave shaped output voltage gently rises until 230V/50Hz \pm 1% (or 115V/60Hz \pm 1%) is reached, ready to power your appliances.

When the inverter is not supplying power to an appliance for an extended time, it is recommended to use the inverter in *Automatic Standby* (ASB) mode to reduce the inverter's own power draw. In this case the power switch must be pushed in the 'II' position. In ASB mode the inverter will generate a testpulse on it's output once per second, to check that there is a load applied. When the ASB mode is activated (by generating a reversed two tone beep), the blue AC Present LED will flash continuously for 4 seconds while the inverter outputs a continuous 230V (or 115V) sinewave. After this 4 seconds the continuous output will change to a pulsed output. Every time this pulse is generated the blue LED is activated too, in order to indicate that there's a lethal AC voltage present at the output. When a load is connected to the inverter output (or switched on) drawing more than approx. 10W, the inverter jumps to the continuous mode immediately, delivering power to the load. When the load is disconnected again (or switched off) the blue LED starts flashing for 4 seconds and the inverter jumps back to the pulsed output ASB mode. This way the inverter automatically jumps to a low power 'sleep' mode when there is no power demand on the output.

Note that some loads like TV/video equipment (with standby mode) and alarm clocks need continuous power so that the ASB mode can not be used.

With some small non compensated loads, it is possible that the inverter jumps from continuous output to pulsed output and vice versa all the time. In this case you have to connect a small additional load to the AC output.

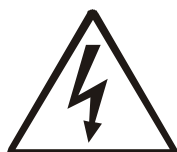

WARNING

IF THE INVERTER JUMPED INTO AN 'ERROR MODE' (SEE CHAPTER 3.1) DUE TO AN OVERLOAD OR SHORT CIRCUIT, THE INVERTER WILL AUTOMATICALLY RESTART AFTER ABOUT 18 SECONDS.

In case of a high temperature error, the inverter will automatically restart after it has reached an acceptable temperature. Right *before* the inverter will restart, it will warn you with a short beep.

NEVER SERVICE THE AC CONNECTIONS WHEN THE INVERTER IS STILL RUNNING IN AN ERROR MODE!

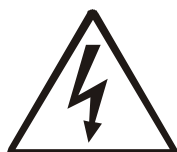

WARNING

THE LARGE BUILT IN ELECTROLYTIC CAPACITORS CAN HOLD SIGNIFICANT DC VOLTAGE WHEN THE BATTERIES ARE DISCONNECTED.

To avoid sparks or short inverter operation, it is advisable to switch on the inverter for 10 seconds after battery disconnection, before you transport the inverter.

3. SELF DIAGNOSIS SYSTEM / TROUBLESHOOTING

3.1 The blink sequence table

This Phoenix inverter is equipped with a self diagnosis system, to inform you about the cause of inverter shut down. To visualize this, the **red** Error/Overload LED can blink in four different sequences. The duration, or timeperiod, of this sequence is about 1 second. During this timeperiod the red LED can blink four times in a row at most. The number of blinks in this time period indicates the cause of inverter shut down.

In the table below you can find out what kind of blinking sequence belongs to which error.

Red LED conditions :	
● = LED blinking ● = LED ON ○ = LED OFF	
Time period (1 second)	Type of error
●○○○	Battery voltage too low or too high (one blink per second)
●●○○	Overloaded or shorted output (two blinks per second)
●●●○	Inverter temperature too high. Cooling down (three blinks per second)
●●●●	Too high input ripple voltage (four blinks per second)
● → Overload, output in current limit	



WARNING

IN A 'BATTERY VOLTAGE TOO LOW OR TOO HIGH' ERROR, THE INVERTER WILL AUTOMATICALLY RESTART WHEN THE BATTERY VOLTAGE IS IN NORMAL SPECIFIED RANGE AGAIN.

IN AN 'OVERLOADED OR SHORTED OUTPUT' ERROR, THE INVERTER WILL AUTOMATICALLY RESTART AFTER APPROX. 18 SECONDS

IN AN 'INVERTER TEMPERATURE TOO HIGH' ERROR, THE INVERTER WILL AUTOMATICALLY RESTART WHEN THE TEMPERATURE HAS FALLEN TO AN ACCEPTABLE LEVEL AGAIN.

IN A 'TOO HIGH INPUT RIPPLE VOLTAGE' ERROR, THE INVERTER WILL NOT AUTOMATICALLY RESTART BUT NEEDS TO BE RESET MANUALLY.
 Manual reset is necessary to notify the user that something is wrong with the inverter's installation (too small battery, too long or thin DC wires etc.)

3.2 Acoustic messages

To warn you before the inverter might shut down, it is equipped with an acoustic alarm. This can be very useful when you are, for example, working with a computer that runs from the inverter. The inverter will warn you just before it is going to shut down, so you can save or finish your work before you lose power.

There are three kinds of acoustic messages depending on the cause of possible inverter shutdown. These messages are related to the red LED blinking sequences mentioned previously.

- Message 1: **One beep per second.** The battery voltage has reached a too low or too high level. If the battery voltage respectively decreases or increases any further, the inverter shuts down.
- Message 2: **Two beeps per second.** The inverter will shut down soon due to an overloaded output. Note that with heavy overloads the alarm will not sound due to rapid inverter shut down. Normally the inverter warns approx. 10 seconds before shutdown.
- Message 3: **Three beeps per second.** The inverter will shut down when it's temperature rises another two degrees Celsius.

3.3 Troubleshooting guide

PROBLEM : Inverter is not working (AC Present LED OFF)	
Possible cause :	Remedy :
Power switch in OFF (0) position	Push the power switch either in the ON (I) or in the ASB (II) position.
Poor contact between the inverter's battery wires and the battery terminals.	Clean battery terminals or inverter wire contacts. Tighten battery terminal screws.
Blown inverter fuse	Replace damaged fuse with the correct type . Make sure you disconnect the battery before changing the fuse. See chapter 5.2 for further information regarding fuse replacement.
Very poor battery condition	Replace battery or charge it first
Remote ON/OFF switch link removed and/or remote switch in OFF position	Make sure that there is a closed circuit between the two Remote ON/OFF switch contacts to start the inverter.

PROBLEM : 'Battery voltage too low or too high' error keeps on appearing	
Possible cause :	Remedy :
Poor battery condition	Replace battery or charge it first
Poor connection or inadequate wiring between battery and inverter, resulting in too much voltage drop	When extending the battery wires of the inverter make sure you use the correct wire gauge (≥ 1.5 times larger than the fixed battery wires). It's not advisable to extend the battery wires to more than 3 meters.
General failure in your electrical system (in case of no direct battery connection)	Check your electrical system or consult an electrical engineer to check it for you

PROBLEM : 'Overloaded or shorted output' error keeps on appearing	
Possible cause :	Remedy :
Inverter is overloaded	Make sure that the total power rating of the connected equipment is lower than the nominal inverter power rating.
Connected equipment features a bad power factor ($\cos\phi$ at sinusoidal currents)	reduce the required power consumption of the load. Please note that for example a computer load features a bad power factor, which causes a reduction of the maximum output power of the inverter by approx. 20%.
Connected equipment causes a short circuit at the inverter's output	Make sure that the connected equipment is not broken or malfunctioning. Check if the AC power cord between the inverter and the connected equipment is ok. Any physical damage on the power cord can produce a short circuit. <i>Be careful in this kind of situations!</i>
Connected equipment produces a too large inrush current (The red Error/Overload LED stays on at load startup)	Try to power-up connected equipment successively, and not simultaneously. Or connect the load first and then turn-on the inverter. Otherwise stop using the connected load, it's not suitable to drive it with this inverter

PROBLEM : 'Inverter temperature too high. Cooling down' error keeps on appearing

Possible cause :	Remedy :
Airflow around the inverter is obstructed	Make sure there is at least 10 centimeters of clearance around the inverter. Remove any items placed on or over the inverter. Keep the inverter away from direct sunlight or heat producing equipment
Too high ambient temperature	Move the inverter to a cooler place or provide additional cooling by an external fan

Note : Don't turn off the inverter when it's operating in an 'Inverter temperature too high. Cooling down' error. The inverter needs this error time to cool down.

PROBLEM : 'Too high input ripple voltage' error keeps on appearing

Possible cause :	Remedy :
Input voltage ripple is too large caused by poor inverter installation	Reduce load, enlarge battery capacity, make sure the DC wires are not extended too long (<3 meters) and that sufficient wire gauge is used (>1.5x the standard equipped wire gauge), check eventual generators/dynamos/high ripple chargers which are connected to the same DC system.

PROBLEM : Inverter jumps between continuous mode and pulsed ASB mode all the time

Possible cause :	Remedy :
Connected load is not compensated or the ratio between inrush current and continuous current is too large.	Connect an additional load to the output.

If none of the above remedies will help solve the problem you encounter, it's best to contact your local Victron Energy distributor for further help and/or possible repair of your inverter. Do not try to repair the inverter yourself, there are dangerous high voltages present inside. Attempts to repair and/or modify the inverter will directly void your warranty.

4. WARRANTY

Victron Energy warrants this inverter to be free from defects in workmanship or materials for 24 months from the date of purchase. During this period Victron Energy will repair the defective inverter free of charge. Victron Energy is not responsible for any costs of the transport of this inverter.

This warranty is void if the inverter has suffered any physical damage or alteration, either internally or externally, and does not cover damage arising from improper use, attempting to operate the inverter with excessive power consumption requirements, or from use in an unsuitable environment.

This warranty will not apply where the product has been misused, neglected, improperly installed or repaired by anyone other than Victron Energy. Victron Energy is not responsible for any loss, damage or costs arising from improper use, use in an unsuitable environment, improper installing of the inverter and inverter malfunctioning.

5. MAINTENANCE / FUSE REPLACEMENT

5.1 Maintenance

Your Phoenix inverter does not need any specific maintenance besides checking all DC and AC connections at least once a year. Check if all nuts and bolts in the electrical system are still tightened sufficiently and if that cables are in good condition. Keep the inverter reasonably clean and remove dust/fibres gathered at the fan in- and outlets to avoid airflow obstruction.

5.2 Replacing fuses

The inverter is equipped with two internal fuses, one on the DC side and one on the AC side. These fuses will only blow in case of serious malfunction and/or external inverter abuse like reverse polarity of battery connections. Both fuses can be accessed by removing the cover of the enclosure as described below.



CAUTION

BEFORE OPENING THE INVERTER TO REPLACE A FUSE, ALWAYS DISCONNECT THE BATTERY FROM THE INVERTER FOLLOWED BY DISCHARGING THE INTERNAL CAPACITORS BY PUSHING THE POWER SWITCH (OF THE DISCONNECTED INVERTER) IN THE 'I' POSITION FOR 10 SECONDS.

1. Unscrew the 8 top cover screws (4 on each side, see picture below) to lift the top cover enabling access to the internal fuses. To make removing the top cover easier, it is advisable to slightly unscrew the remaining left- and right screws on one side of the inverter.

Remove these four screws at both ends of the inverter enclosure

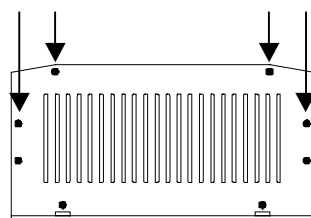

1

Gently lift the cover upwards

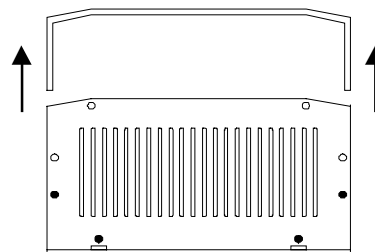

2

2. Now the top side of the main PCB is visible as well as the location of the two fuses. See the figure below for the fuse locations.

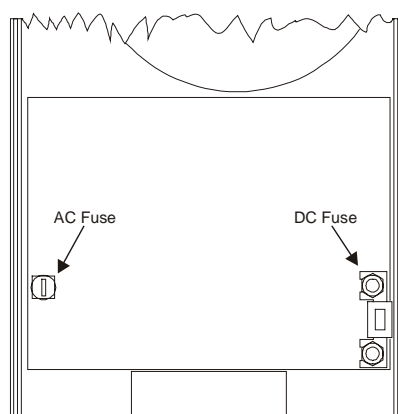

FUSE TYPES		
Model	AC fuse	DC fuse
Phoenix 12/1000	5x20mm 10Amp/250V slow blow	Pudenz type no. 156.5611.6121 125Amp automotive strip fuse

3. The AC side fuse can be replaced by turning and pushing the plastic cap counter clockwise until the cap releases and can be pulled out. The DC fuse can be replaced by unscrewing the two nuts. Make sure the new fuse is inserted in exactly the same position as the previous one (see picture below). Apply sufficient torque to the nuts so that the spring washers are fully compressed, but avoid bending the main PCB.

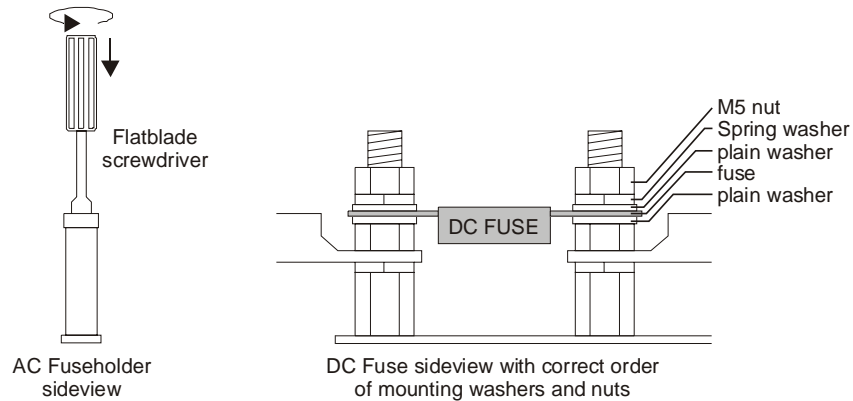

4. Place the cover carefully back again, without hitting the internal DC fuse and/or frontpanel printed circuit board. Put all eight screws including the spring washers back in place. Now you can reinstall your inverter. If the replaced fuse blows again while the inverter is installed correctly, the unit must be returned for service to your local distributor.

6. TECHNICAL SPECIFICATIONS / DECLARATION OF CONFORMITY

6.1 Phoenix 12/1000

TECHNICAL DATA	
	Phoenix 12/1000
Cont. output at 25°C ²⁾	1000VA
Cont. output power at 25°C ¹⁾	850W
Cont. output power at 40°C ¹⁾	800W
Peak power	1800W
Short circuit output current	≈ 8A
Output voltage	230Vac or 115Vac ± 1%
Output frequency	50Hz or 60Hz ± 0.05%
Output waveform	True sinewave (THD < 5% @ Pnom)
Admissible cos φ of load	0.5 – 1
Input voltage :	
Nominal	12VDC
Range (static)	10.5 – 16VDC
Range @ 1000VA	9.7 – 16VDC
Maximum input ripple voltage	≈ 1.3VACrms
Efficiency	
Maximum	92%
@ Pnom	83%
No load power consumption at nominal input voltage	< 7.5W
No load power consumption at nominal input voltage in automatic standby mode	< 1.5W
Automatic standby threshold	Pout = 5W
Operating temperature range (ambient)	0 .. 40 °C
Protections against	Short circuit, overload, high temperature, low battery voltage and high input ripple voltage
Error indications (by preprogrammed blinking sequences of the red LED)	Short circuit/overload, high temperature, high/low battery voltage and high input ripple voltage
Other indications	Overload (red LED) AC Present (blue LED)
DC input connection	two wires, length 1.5 meters, area Ø 25mm ²
AC output connection	IEC320 type AC outlet
Enclosure body size (l x h x w)	355 x 105 x 206mm (without mounting brackets)
Protection class	IP20
Inverter weight	10.5 kg
The inverter complies with the following standards :	EN50081-1 Generic Emissions Standard EN50082-1 Generic Immunity Standard EN60950 Safety Standard EN60742 Transformer Standard

Note : the given specifications are subject to change without notice

¹⁾ Measured with resistive load.

²⁾ Non linear load, crest factor 3:1

6.2 Declaration of conformity



IMPORTER : Victron Energy
ADDRESS : De Paal 35
1351 JG Almere-Haven
The Netherlands

Declares that the following products :

PRODUCT TYPE : DC TO AC SINEWAVE INVERTER
MODELS : - Phoenix 12/1000

Conforms to the requirements of the following Directive of the European Union :

EMC Directive 89/336/EEC

The above products are in conformity with the following harmonized standards :

- EN50081-1 : 1994 EMC - Generic Emissions Standard
- EN50082-1 : 1997 EMC - Generic Immunity Standard

Signed : R. Vader

A handwritten signature in black ink, appearing to read 'R. Vader', written in a cursive style.

Authority : Managing Director

Date : 27 November 2002

Stock number:
Dealer:

Victron Energy B.V.
The Netherlands

General phone: +31 - (0)36 - 535 97 00
Customer support desk: +31 - (0)36 - 535 97 77
General and Service fax: +31 - (0)36 - 531 16 66
Sales fax: +31 - (0)36 - 535 97 40

E-mail: sales@victronenergy.com
Internet site: <http://www.victronenergy.com>

Doc. no. ISM010037000-REV00.doc
Date 27-11-2002